



Portable Internet Radio

WR-26F

User Manual



Please read this user manual carefully before using the receiver.

Contents

1. Introduction to the WR-26F Internet Radio	4
2. Location of controls	5
3. Choosing options and functions	7
4. Network Setup	8
5. Overview of Radio modes and functions	10
6. My Favorite	12
7. Internet Radio	13
8. Media Center	15
9. FM Radio	16
10. Bluetooth Speaker	17
11. Sleep Timer	18
12. Configuration	19
13. Skytune Web Application for Internet Radio www.skytune.net	21
14. Problems and Solutions	23
15. Technical Specifications	25

Introduction to the WR-26F Internet Radio

The WR-26F Internet Radio is a compact and light weight portable radio with an internal 2000 mAh Li-Ion rechargeable battery for many hours of audio entertainment and a gateway into the world of digital audio.

There are seven different operating modes requiring different wireless connections as listed below:

- 1) My Favorite (No Wi-Fi or Internet)
 - List of previously Preset favorite listening choices
- 2) Wireless Wi-Fi (Internet connected)
 - Internet Radio with more than 30 thousand radio stations worldwide
- 3) Media Center (Wi-Fi - no Internet)
 - Play music streamed over the Wi-Fi network by a UPnP or DLNA server e.g. smart phone, laptop.
- 4) Wireless (direct broadcast – no Internet or Wi-Fi)
 - FM Radio
- 5) Wireless (Bluetooth – no Internet or Wi-Fi)
 - Play audio transmitted from a Bluetooth source e.g. smart phone, Laptop.
- 6) Timer (no Wi-Fi or Internet)
 - Adjustable timer to delay putting the Radio into Standby mode
- 7) Configuration (no Wi-Fi or Internet)
 - Set up, options and information center

Precautions

Charge the battery with a USB charger – do not apply any other power source or permanent damage to the radio will occur and may be hazardous.

To clean use only a damp cloth and dry with a clean towel - keep away from all liquids.

To avoid loss of warranty do not attempt to repair or remove the cover for any reason.

2

Location of controls

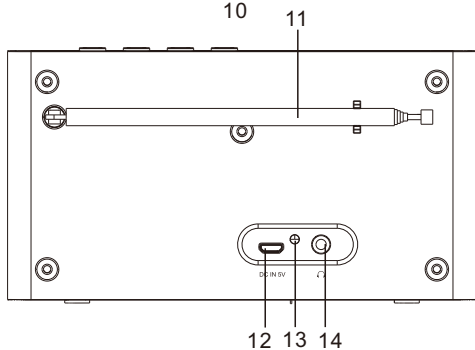
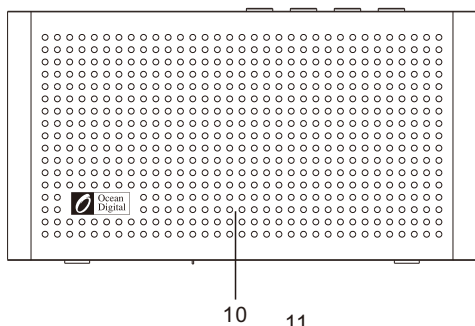
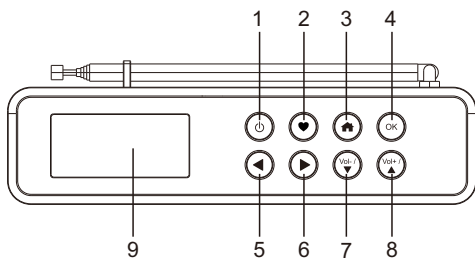

Location of controls

- 1) Press and Hold – turn On/Standby (On/Off without USB power)
- 2) Press and Hold – add to Favorite list
Press and Release – display the Favorite list
- 3) Main menu – go to My Favorite
- 4) Confirm selection
Internet Radio – Stop playing / Resume Playing
FM and Bluetooth – Mute
- 5) Move Back – previous menu
Bluetooth – replay previous song
- 6) Move Forward – next display or next in list
Playing – Display Clock, Battery level and Radio station information
Favorite list – go to Edit list mode
Bluetooth – skip to the next song
- 7) Decrease volume (Hold for continuous decrease)
Move down list
- 8) Increase volume (Hold for continuous increase)
Move up list
- 9) Color Display
- 10) Loud speaker
- 11) Telescopic FM radio antenna
- 12) Micro USB connector for battery charging
- 13) LED – Red battery charging / Green charging complete
- 14) Headphone 3.5 mm connector

3

Choosing options and functions

All user input is information that the Radio uses to provide the desired audio entertainment with select (OK button) a confirmation and go to command.

Navigate to a function (i.e. My Favorite, Internet Radio, Media Center, FM Radio, Bluetooth, Sleep Timer and Configuration) or a position in a list by using the Move Forward (▶), Move Back (◀), Move Up (▲) and Move Down (▼) controls.

Once a desired selection is displayed or highlighted the selection is confirmed by pressing and releasing the **[OK]** button.





Throughout this manual “Select” will mean navigating through option lists or display screens until the desired selection is displayed or highlighted and confirming it by pressing and releasing the **[OK]** button.

4 Network Setup

The Internet Radio must have a high bandwidth internet connection and a wireless (Wi-Fi) home network connected to it to be fully functional.

To configure the Wi-Fi network connection turn on the radio by pressing and holding [] button until the display illuminates - this normally takes 3 - 5 seconds.

The first time the Radio is turned on after leaving the factory a Configure Network wizard is automatically started:

- 1) Highlight and Select Yes to connect to the Wi-Fi network
- 2) The display will change and display a list of options – Select Add AP (Scan)
- 3) The display will show a list of available networks – Select your network
- 4) The display will ask for your passcode/password – using the [] and [] buttons highlight the first digit and press [] button to confirm and input the next character. highlight the next digit and press [] button to move forward. Repeat until the last digit is highlighted. While the last digit is highlighted Select by pressing and releasing the [**OK**] button. If the wrong character be input, press [] button to delete it.
- 5) If the connection is successful “Association Complete” will be displayed briefly.



Network Setup

To repeat the above procedure, or if the Configure Network wizard does not automatically start, the network can be connected by using the Configuration mode.

- 1) Press the [] button to go to the mode selection options
- 2) Select Configuration
- 3) Select Network

There are two different options to connect to the network from the Configuration mode:

- 1) Repeat steps 1) through 5) above page 8.
- 2) Select Add AP (WPS button) – Press WPS button on your router within 2 minutes to complete the connection.

Connection status is displayed on the bottom left hand corner of the LCD with the Wi-Fi symbol and signal strength bars ( ).

For best Wi-Fi performance, limit “drop outs” (interruptions) the Wi-Fi Channels must be set according to the location of the Radio e.g. China, USA, Europe. The factory default is China.

To set the correct location, select Configuration>Network>Wi-Fi Channels and select the correct option.

5

Overview of Radio modes and functions

To Select any mode use the Menu button [] on top of the radio to display the My Favorite screen:

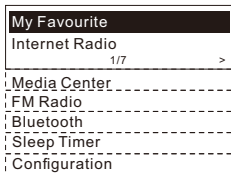

Navigate through the modes to find and Select any of these functions:

- 1) **My Favorite** – A maximum of 99 previously saved (Preset) favorite listening sources are listed for Selection.
- 2) **Internet Radio** – Select online radio station from the thousands available on Skytune or by using the History list of previously selected radio stations or use search to find a preferred radio station.
- 3) **Media Center** – Browse and Select music streaming on your home Wi-Fi network by any UPnP or DLNA compatible server e.g. Smart phone, Tablet, PC, Laptop.
- 4) **FM Radio** – Play your favorite local radio station using the telescopic antenna.
- 5) **Bluetooth** – When “Paired” (connected) to another Bluetooth device use the Radio as a powered speaker. Maximum range of the Bluetooth wireless signal is 10 meters (32 feet) but may be reduced by the presence of walls or other obstructions.

Overview of Radio modes and functions

- 6) **Sleep Timer** – Select a time delay before the Radio goes to Standby mode while playing your selected audio entertainment source – only available if the radio is connected to a USB charger.
- 7) **Configuration** – This mode lists all available options and settings to personalize your Radio.

6

My Favorite

This mode displays a list of up to a maximum of 99 audio sources that have been Preset (stored) using the Preset button (♥) on top of the radio while an audio source is playing.

After the first 99 presets the next Preset will be stored in the first location, the next in the second location continuing to overwrite each list location until it loops back to the first location again.

To Edit the list highlight a list item then press the Move Forward button (►) on top of the radio to move to the Edit list function where the item can be moved Up, Down or Deleted from the list.

7 Internet Radio

Select Internet Radio mode using the [] button on the top of the radio and navigate to Internet Radio. Navigate the extensive list of available worldwide radio stations using these options:

- 1) Skytune – Select a radio station using the structured lists that aid and reduce the task of finding the right station.
- 2) Use Search instead of browsing the extensive radio station list by using the initial letters of the desired station name, creating a shorter list of stations the more characters used in the search.
- 3) The History option will show a list of the radios stations recently selected. Every station selected is added to the list automatically until a maximum of 99 is reached when the next station selected will replace the first station in the list.
- 4) Add a radio station – see “Skytune Web Application for Internet Radio” in a later section of the manual.

When playing Internet stations information about the station and what is playing will be displayed on the LCD screen.

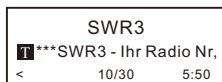

Radio Stations can be added to the My Favorite list at anytime a station is playing using the Preset () button on the top of the radio. When a Preset is added the icon (--> FAV) is displayed as shown below.

Internet Radio

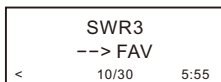

A maximum of 99 Presets can be added to the list before the next Preset will overwrite the first item in the list.

Use list Edit options to move an entry Down, Up or Delete by highlighting the station to edit and pressing the Move Forward button (►).

The Radio supports the industry standard Universal Plug and Play (UPnP) and Digital Living Network Alliance (DLNA) standards.

This enables the Radio to browse and play music files located on an UPnP or DLNA server provided the server has been setup to allow sharing of files on the network.

Set up Media Center playback options in Configuration and Select the Media Center to display a list of options:

- 1) UPnP – A scan is made to find UPnP and DLNA devices that are streaming on the Wi-Fi network (this can take a few seconds) and when complete options are listed to select music or playlists files. If no UPnP or DLNA servers are found “Empty List” is displayed.
- 2) My Playlist – Your own play list may be created by playing selected music and while it is playing pressing and holding the **[OK]** button until the Preset symbol (--> FAV) is displayed.
- 3) Clear My Playlist – Select to delete all music files from My Playlist.

9

FM Radio

Select FM Radio and press [**OK**] button if option to Scan and Preset FM Stations is displayed or if a list of Preset FM stations is displayed select station to start listening.

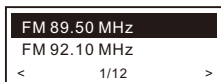

While a station is playing information about the station is displayed and it can be added to the Favorite list by pressing the Preset button (**♥**) on top of the radio.

Note: Changes to the available FM stations will not be included in the available station list without a new scan for stations. To rescan go to Configuration>FM Setup>FM Full Scan.

Press the [**OK**] button until "Tuning" is displayed in the lower right corner of the LCD screen. The Move Forward (**▶**) or Move Back (**◀**) buttons can be used to go up or down in frequency.

To exit manual tuning long press [**OK**] button.

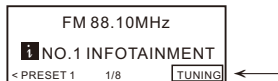

10 Bluetooth Speaker

After selecting Bluetooth the display will show the Radio's Bluetooth identifier code and connection status. If it is not connected "pairing" must take place with the audio source Bluetooth device.

When the Radio's identification code appears in the list of local Bluetooth devices on the audio source Bluetooth device pair the two devices so that they can recognize each other and will automatically connect whenever the Radio is in Bluetooth mode and in range.

Once pairing is complete the audio file being transmitted by the Bluetooth device will be received by the Radio and played the same as any other audio source.

11 Sleep Timer

To save battery power the Sleep Timer function, we prefer to use this function with the radio is connected to the USB charging power source via the USB cable

Set the timer to turn the radio off after the selected time elapsed in the range of 15 to 180 minutes.

12 Configuration

Select Configuration for a list of adjustments and options to be displayed, navigate the list and select the desired function, use the Move Forward / Back (► / ◀) controls to go forward or backwards in the decision tree and press [OK] button to make selection.

Network

Wi-Fi Network

- Network Options – Select if the Radio should be permanently connected or to disconnect if the connection is not active for more than 30 seconds.
- Wi-Fi Channels – Select your location to minimize interruption (drop outs) of the audio stream e.g. music.
- Wi-Fi Network
 - Add/Remove AP – Scan local area to find and list available Wi-Fi networks
 - AP:[] – If there is more than one router on the network select the one for the Radio to use.
 - Signal – Display Wi-Fi signal strength
 - IP [current setting] – Factory Reset default is Dynamic
 - DNS [current setting] - Factory Reset default is Dynamic

Date & Time – Set up and select options for time zone, clock and date formats, adjust for day light saving time, network time, NTP server address, and FM time.

Configuration

Language – Select language

FM Setup – Options to select FM area, scan for FM stations to create station list and display station list

Local Radio (United States) – Option to automatically set local stations or set manually

Playback Setup – Options to repeat all, repeat one, shuffle or normal

Resume play options – play when ready or do not start playing

Power-on options – resume from last or go to Standby

Dimmer – options to set LCD brightness levels in play and Standby – set Dim and Bright light levels independently from dark to full brightness

EQ [current setting] – options for playback sound e.g. Flat, Rock, Classical

Buffer Time [current setting] – select either a 2 or 5 second minimum amount of audio streaming data in the buffer (storage) when recovering from breaks in the Internet data stream

Information – Network and System information

Software Update – Request an update to the system software. Do not turn off the radio until the update has completed. If an error occurs or radio hangs up (i.e. becomes unresponsive) press and hold both the power On/Off and Mode buttons until the radio turns off.

Reset to default – reset all the Radio settings and options back to the exit factory condition

Browse / Search

On the opening page click Browse / Search at the lower right side of the page.

Enter the name of a Radio Station or Browse the structured list of stations available, select the one of interest and click on the heart symbol (♥) - the station logo is displayed.

The Radio connection page will ask if the station is to be played or saved in My Favorite list in your Radio.

To make an Internet connection to the Radio it's IP address must be entered in the space provided on the web page – the Radio IP address can be found by going to Configuration>Information>Network Information.

Once the IP address has been entered select Save or Listen, click Send and My Favorite web page will be displayed i.e. a duplicate of your Radio My Favorite list.

The list can be edited using the tools provided on the web page with any changes sent to the Radio's My Favorite list automatically.

Request to add Radio Station

If you know the name of a Radio Station but it is not in the list a request can be made to have it added.

On the opening page select the Suggest Station tab and fill in the application.

Adding a Radio Station

To add a Radio Station its name and URL can be entered

in the Add Channel section along with selecting the Country where it is located and Genre of audio entertainment it provides.

Smart Phone, Tablet or Computer Control

With device connected to the same Wi-Fi network as the Radio use web browser to edit lists and add radio stations.

Enter the Radio IP address

(Configuration>Information>Network to find IP address)

as web address and a window will open to edit lists e.g.

add your favorite radio station URL if it is not in the list.

14 Problems and Solutions

Cannot connect to the Wi-Fi Network

a) Common Causes

- Incorrect passcode / password for the selected Network.
- Location of the Radio has a weak Wi-Fi signal – if possible check with another Wi-Fi connected device in the same location or move to a location closer to your router.

b) Unusual Causes

- Incorrect Network security encryption – Radio supports WEP, WPA and WPA 2

Cannot play UPnP or DLNA Files

- There is no UPnP or DLNA server.
- The UPnP server is not streaming files over the Wi-Fi Network.
- The server is not correctly configured to allow sharing of files over the network

Internet Radio has interruptions (drop outs)

- Wi-Fi Channel interference – incorrect region selected
Configuration>Network>Wi-Fi Channels.
- Weak Wi-Fi signal – check the Wi-Fi symbol (bottom left hand side of LCD display) for a minimum of two “Bars” - add a Wi-Fi Extender to the Network if necessary.
- Radio Station has interrupted streaming – check by trying a stations in the Skytune> Globe Most Popular list.
- The Internet connection does not have sufficient bandwidth (capacity) to support all the devices connected to the Network when operating at the same time or is experiencing excessive error rates – have the

Problems and Solutions

Internet connection checked by the ISP (Internet Service Provider).

Internet Radio cannot play some stations

- The station may not be streaming – not all stations stream for 24 hours a day.
- There are too many users at this time – some stations have a limited number of users they can support at any given time.
- The station link is out of date – it is updated daily and should be correct the next day.
- The station link is no longer active – the station is no longer available.

FM Radio has poor reception

- The telescopic antenna not fully extended – make sure it is pulled out to its full length and try different positions.
- Weak radio signal in this location – the closer to windows the stronger the signal will be.

15 Technical Specification

Model: WR-26F

DC Power Input: 5 Volts 1 Amp. (USB)

Battery: Li-Ion 2000 mAh

Wi-Fi Wireless Network: IEEE 802.11b/g/n (5 GHz only
version ac – not supported)

Frequency: 2.4 GHz

Security: WEP, WPA, WPA2

Bluetooth Version: V4.2 BR, EDR Compliant

Frequency: 2.4 GHz

Range: 32 Feet (10 meters) Line of sight

Transmit Power: 0 dBm - Receive only (not for
headphones)

Audio File Streaming Formats

UPnP: MP3, AAC, AAC+, WAV

DLNA: MP3, AAC, AAC+

FM Radio Frequency: 87.5 – 108 MHz

Audio Output: 1.5 Watts

Analogue: 3.5 mm Stereo Headphone

Dimension: 6.25" x 3.5" x 1.75"

Weight: 0.75 Lbs

IN THE BOX

- * Internet Radio
- * User Manual
- * USB Cable

WEEE and Recycling



The European laws do not allow any more the disposal of old or defective electric or electronic devices with the household waste. Return your product to a municipal collection point for recycling to dispose of it. This system is financed by the industry and ensures environmentally responsible disposal and the recycling of valuable raw materials.

Ocean Digital Technology Ltd.
Flat B, 12/F., Yeung Yiu Chung (No.8) Ind. Bldg.,
20 Wang Hoi Road, Kowloon Bay,
Hong Kong
Email: support@oceandigital.com.hk